

PROMOTIONS

Valid from January 1st to June 30th, 2026

1st half 2026

Updated Offers Inside:
TungMeister and
DrillMeister!

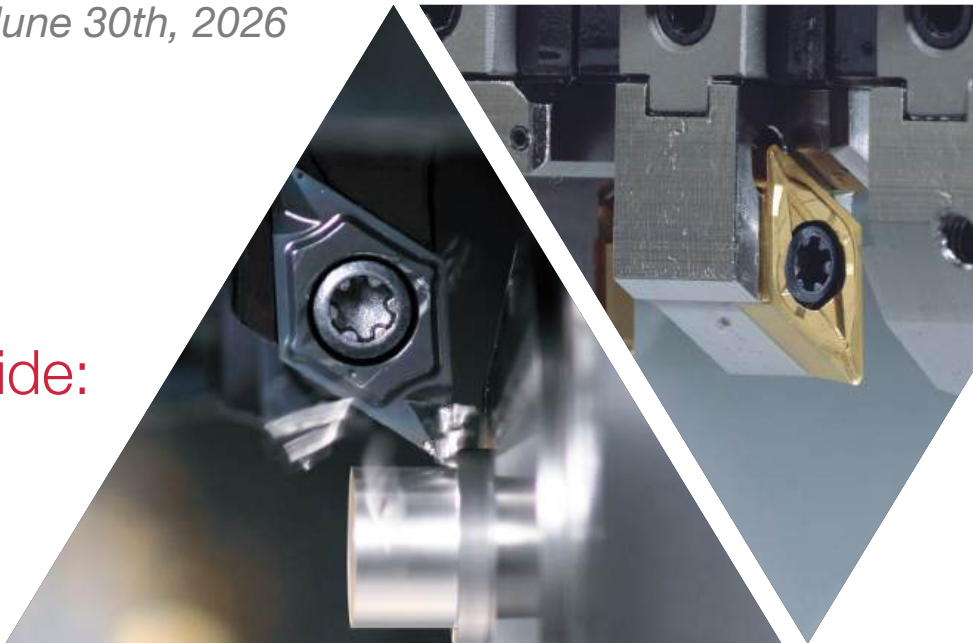

AFC Tooling
AFCTooling.com

T6200 SERIES

Valid from January 1st to June 30th, 2026



HIGH-PERFORMANCE GRADE SERIES FOR STAINLESS STEEL TURNING

T6215 and **T6225** feature a thick, high-adhesion Al_2O_3 coating with a hardened outer layer, delivering superior wear resistance and long tool life

BUY 30 inserts
AND
GET 10 corresponding inserts

FREE of charge!
Promo Code: T6259

*Offer must be ordered through our Customer Service Team, not available on Webshop.

Inserts:
ISO type

M Stainless steel

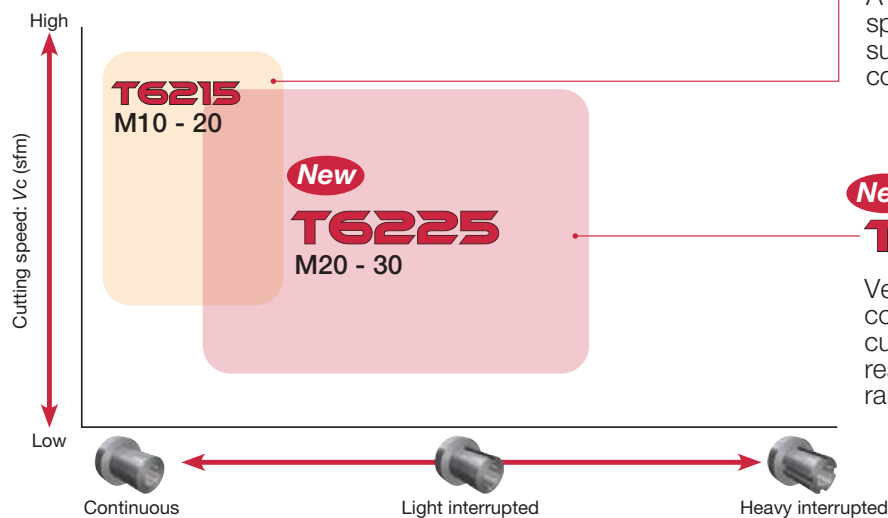

T6215

A CVD-coated grade suited for high speed cutting. Demonstrates superior wear resistance during continuous cutting.



New T6225

Versatile CVD grade covering from continuous to light interrupted cutting. Provides excellent wear resistance in the medium cutting range.

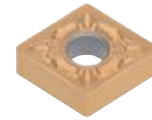

BM05M / SBN30 / BX4015

Valid from January 1st to June 30th, 2026

HIGH-PRODUCTIVITY CBN GRADES FOR MULTIPLE MACHINING MATERIALS

BM05M coated CBN grade for high speed continuous cuts of hardened steel parts

BX4015 CBN grade for sintered alloys

SBN30 CBN grade for high speed machining of cast iron

BUY 8 inserts

AND

GET 2 corresponding insert

FREE
of charge!

Promo Code: TG260

*Offer must be ordered through our Customer Service Team, not available on Webshop.

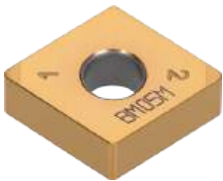

BM05M

First-choice coated CBN grade for high-speed continuous cutting of hardened steel at speeds up to 1,148 sfm.

Inserts:

ISO type:

C, D, G, T, V, W

MiniForce-Turn:

DX, WX



SBN30

Solid CBN grade for high-speed cast iron machining, offering deep cuts, high feeds, and exceptional wear and fracture resistance.

Inserts:

ISO type:

C, R, S

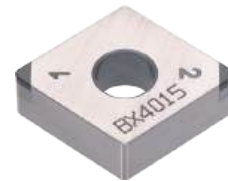

BX4015

CBN grade for sintered alloys, delivering excellent performance in continuous to light-interrupted cuts.

Inserts:

ISO type:

C, D, T, V



MINIFORCE TURN

Valid from January 1st to June 30th, 2026

ECONOMICAL, DOUBLE-SIDED POSITIVE INSERT WITH AN INNOVATIVE GEOMETRY AND SEAT INTERFACE THAT DELIVERS STABILITY AND HIGH PERFORMANCE.

BUY 20 inserts

AND

GET 1 holder

FREE
of charge!

Promo Code: TUS56

BUY 20 inserts

AND

GET 1 CHP holder at

50 %
additional discount!

Promo Code: TUS56

Inserts:

CXMU, DXGU, DXMU, VXGU, WXGU

Toolholders:

A/E-SCLXR/L	JS-SDUXL	JSVJ2XR/L	JSWL2XR/L-X-CHP
A/E-SDXXR/L	JS-SVUXL	JSVJ2XR/L-CHP	JSWLXR-F
A/E-SDZXR/L	JSDJ2XR/L	JSVJ2XR/L-X-CHP	JSWLXR/L
A/E-SWLXR/L	JSDJ2XR/L-CHP	JSVJXR-F	
JPDJ2XR/L	JSDJ2XR/L-X-CHP	JSVJXR/L	
JPVJ2XR/L	JSDJXR-F	JSWL2XR/L	
JPWL2XR/L	JSDJXR/L	JSWL2XR/L-CHP	



SUPERB STABILITY AND PRODUCTIVITY IN DEEP FACE GROOVING OPERATIONS

Newly designed insert profile ensures unobstructed chip flow and consistent chip evacuation.

BUY 20 inserts

AND

GET 1 adapter

FREE
of charge!

Promo Code: TG262

BUY 20 inserts

AND

GET 1 CHP holder at

50 %
additional
discount!

Promo Code: TG262

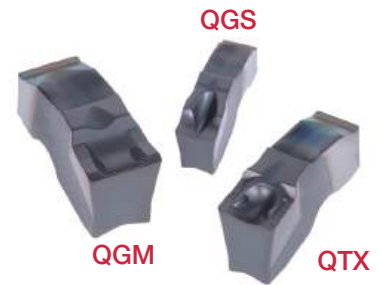

Inserts (Grades AH7025, AH6235):

QGM, QGS and QTX

CW = 0.118", 0.157", 0.197"

Max. grooving depths for face grooving

CDX = 1.65"

Adapters:

QSDR/L-CHP... Face grooving adapter

(for CW = 0.118", 0.157", 0.197",

CDX = 1.02" - 1.65")

Holders for adapters:

QHSR/L-CHP

QHTR/L-CHP

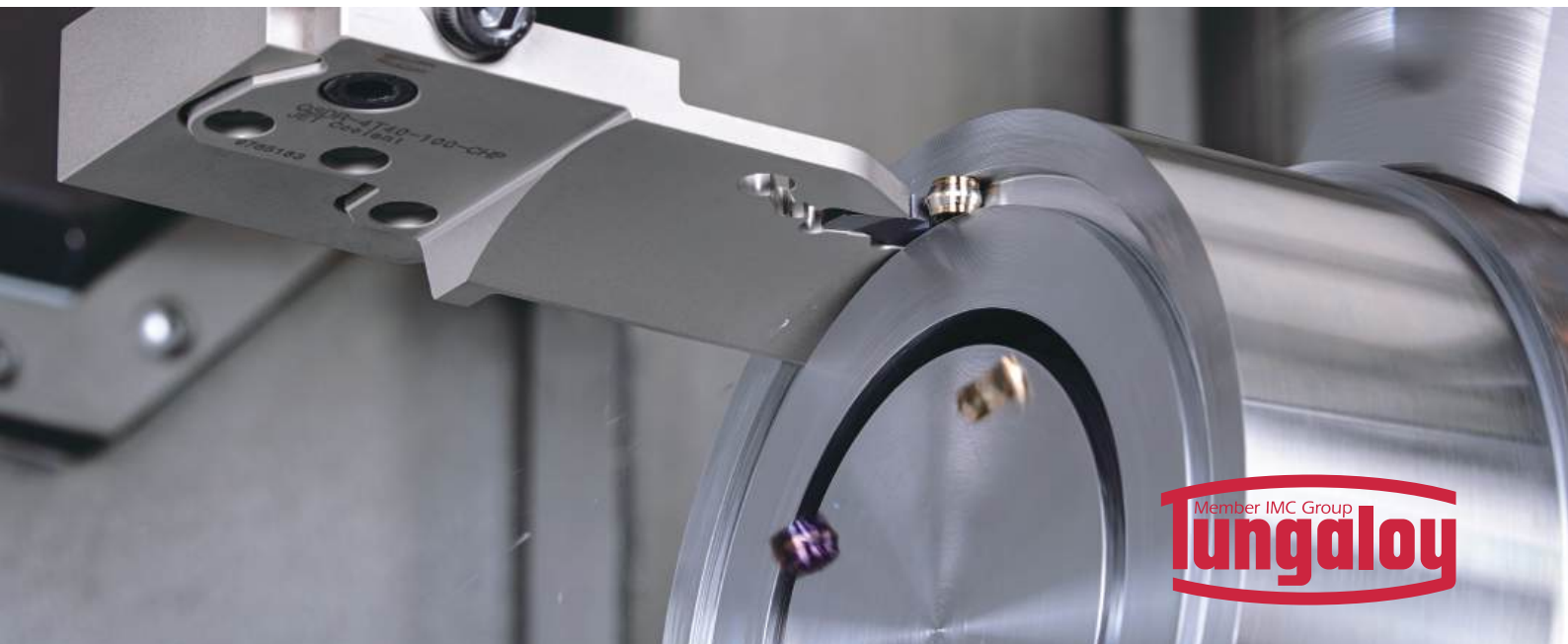

INNOVATIVE 4-CUTTING-EDGE TOOLS FOR FACE GROOVING IN MINIATURE MACHINING

Unique clamping design ensures high rigidity, excellent repeatability, and outstanding productivity.

BUY 10 inserts

AND

GET 1 corresponding toolholder at

60 %
additional
discount!

Promo Code: TG261

Inserts (Grades SH7025,
SH725):
TCF18

Toolholders:
JS-STCFL
STCFVR

TCF18

CW = 0.019" - 0.098"

Max. grooving depth: 0.118"

Minimum grooving diameter: $\varnothing 0.236$ "



DEEP FACE GROOVING OF UP TO 10 MM DAXN AND UP TO 0.354" GROOVE DEPTH IS POSSIBLE

Extremely rigid insert clamping ensures tool stability during deep face grooving operations. Sharp cutting edge, **combined with SH7025, the latest PVD grade**, provides long tool life and superior surface quality. The direct coolant supply from holder and insert geometry effectively redirects chips out and away from the part.

BUY 10 inserts
AND
GET 1 corresponding
toolholder

FREE
of charge!
Promo Code: TG263

Inserts (Grade SH7025):
MFGR...

Toolholder:
A-MFR10...

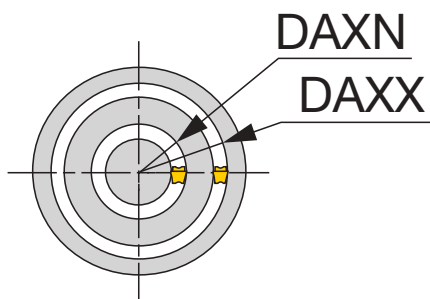

MFGR10



MORE THAN 13,000 POSSIBLE COMBINATIONS

Solutions for conventional and Swiss machining applications. Easy and accurate head-holder coupling provides reduced tool change time and high accuracy of cutting point repeatability. Covers a broad range of applications from precision machining to large parts. Tool Diameter range: 5mm - 32mm / 0.250" - 1.000".

BUY 6 heads

AND

GET 1 steel shank

OR

GET 1 carbide shank at

Promo Code: TG267

FREE of Charge

50% additional discount

Heads (Grade: AH715, AH725, AH750, GH730, KS15F):

Square heads: VEH, VEE, VED

Face mills: VFM

High-feed: VFX

Ball: VBB, VBD, VBE

Radius: VRB, VRC, VRD

Barrel: VBO

Bull nose: VBN

Lens: VBL

Chamfering: VCA, VCW, VCR

Chamfering and spot drill: VCP, VDS

Center drill: VDP

Counterboring: VGC

Multi-function: VVFH

Slotting: VST, VTB

Threading: VMT, VTR



Shanks:

Steel, Carbide, ER collet type



HIGH FEED MILLING CUTTERS WITH SIX CUTTING EDGE INSERTS

The cutter's small entry angle ensures smooth material access, perfect for long reach applications

BUY 10 inserts per pocket up to max 50 inserts

AND

GET 1 cutter

FREE
of charge!

DoFeedTri03 Promo Code: TG264
DoFeedTri06 Promo Code: TG265

Inserts (Grades: AH3225, AH3135, AH130, AH8015):

WXMU03-MM/ML/MS
WXMU06-MM

Cutter bodies:

Bore type:

TXWX03

DCX = $\varnothing 1.500'' - \varnothing 4.000''$ ($\varnothing 40 - \varnothing 80$ mm)

TXWX06

DCX = $\varnothing 2.000'' - \varnothing 4.000''$ ($\varnothing 40 - \varnothing 80$ mm)

Shank type:

EXWX03...

DCX = $\varnothing 0.620'' - \varnothing 1.250''$ ($\varnothing 16 - \varnothing 40$ mm)

Modular type:

HXWX03

DCX = $\varnothing 16$ mm – $\varnothing 40$ mm



HIGH-SPEED, ECONOMICAL FACE MILLING CUTTER DESIGNED FOR HIGH PRODUCTIVITY ACROSS ALL MATERIALS WHILE DELIVERING A SUPERIOR SURFACE FINISH.

BUY 10 inserts per
pocket up to max 50 inserts
AND
GET 1 cutter

FREE
of charge!
Promo Code: TUS61

Limited up to diameter 5.000" (125 mm)

Inserts:
PN*U0905

Cutters:
Shank type: EEN09
Bore type: TEN09

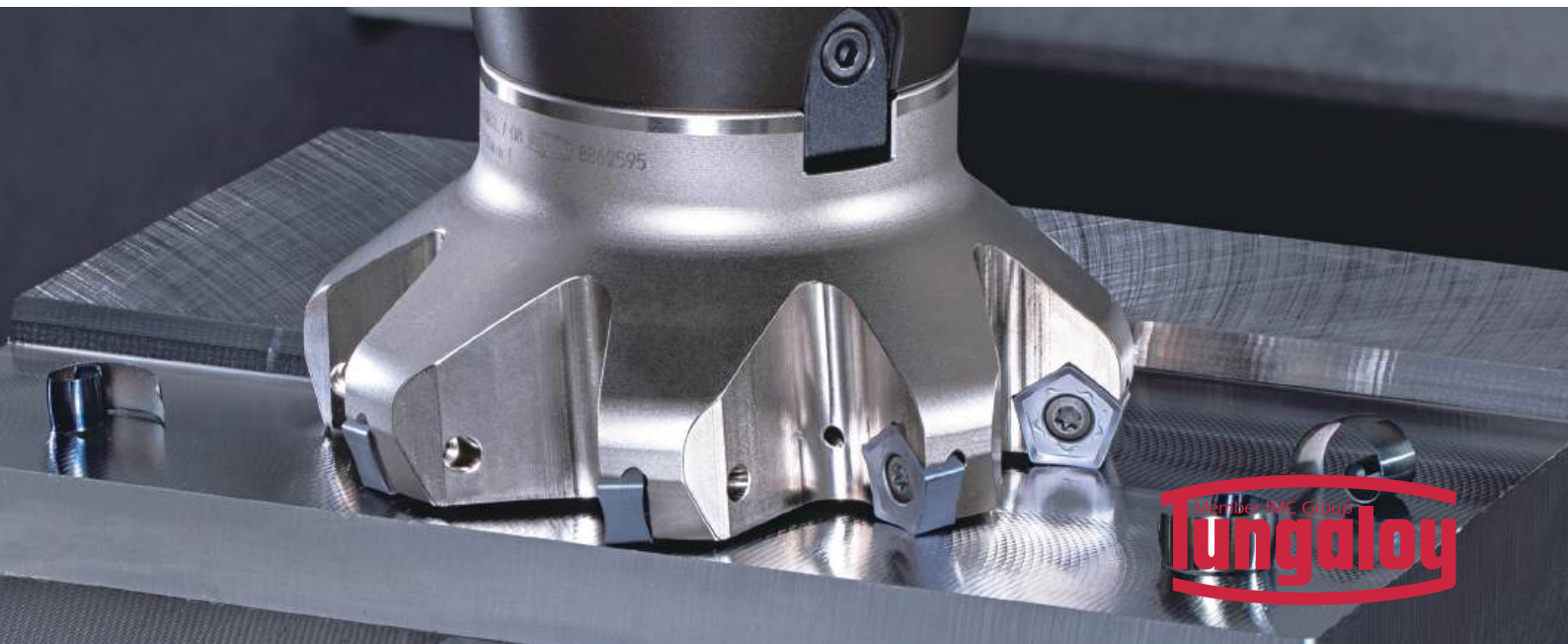

COMPLETE SOLUTION FOR SHOULDER MILLING WITH OUTSTANDING PERFORMANCE AND COST-EFFECTIVE INSERTS

Economical shoulder milling cutter with 3 cutting edged insert with wide range of sizes, grades and diameters.

BUY 10 inserts per pocket
 AND
GET 1 cutter
 up to max 50 inserts

FREE of charge!
 Promo Code: TG266

Limited up to diameter 5.000" (125 mm)

Inserts (Grade: T1215, KS05F, DS2005, T3225, AH8015, AH3135, AH3225, AH120):
 TO*T04/06/10/15 - MJ/MM/AJ/NMJ

Cutter bodies:

Bore type:

TPA06/10/15

DC = $\phi 1.500'' - \phi 5.000''$ ($\phi 32$ mm – $\phi 125$ mm)

Shank type:

EPA04/06/10/15

DC = $\phi 0.500'' - \phi 2.000''$ ($\phi 8$ mm – $\phi 50$ mm)

Modular type:

HPA06/10-M

DCX = $\phi 16 - \phi 32$ mm

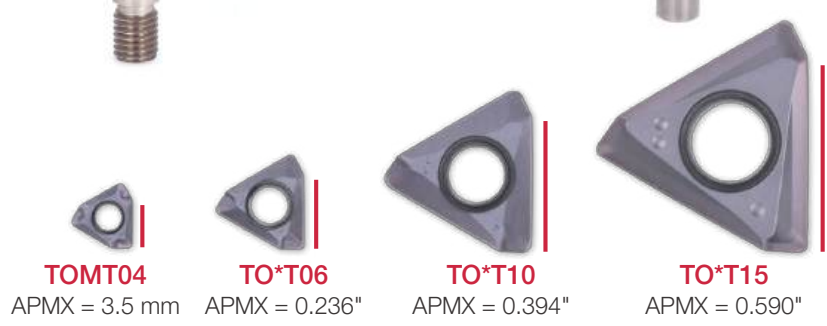

VERSATILE SHOULDER MILLING CUTTER WITH UNIQUE V-SHAPED INSERT BOTTOM FOR MAXIMUM PRODUCTIVITY

Unmatched stability across all materials, with an innovative clamping system

**BUY 10 inserts per
AND pocket UP TO MAX 50 INSERTS
GET 1 Cutter**

**FREE
of charge!**

Promo Codes:
Size 04: TUS57
Size 06: TUS58
Size 12: TUS59
Size 18: TUS60

Limited up to diameter 5" (125 mm)

Inserts (Grades: AH3225, AH3135, AH8015,
AH120, AH130, T1215, T3225 and KS05F):

AVMT04, AVGT06, AV*T12, AV*T18

Cutter bodies:

Bore type:

TPAV**

DC = $\varnothing 1.5'' - \varnothing 5''$

($\varnothing 40 - \varnothing 125$ mm)

Shank type:

EPAV**

DC = $\varnothing 0.313'' - \varnothing 1.25''$

($\varnothing 6 - \varnothing 32$ mm)

Modular type:

HPAV-M** (TungFlex connection)

DC = $\varnothing 10 - \varnothing 40$ mm

HPAV06-S (TungMeister connection)

DC = $\varnothing 10 - \varnothing 16$ mm



AVMT04
APMX:
4 mm



AVGT06
APMX:
0.236" (6 mm)



AV*T12
APMX:
0.453" (11.5 mm)



AV*T18
APMX:
0.650" (16.5 mm)



EXCHANGEABLE HEAD DRILL SYSTEM FOR SUPERIOR DRILLING PERFORMANCE AND LONG TOOL LIFE

Quick drill tip change for reduced machine downtime.

Tool inventory and management costs are significantly reduced as there is no need for regrinding.

BUY 4 drill heads

AND

GET 1 drill body

1.5xD - 3.5xD and Modular type

FREE
of charge!

Promo Codes:

1.5-2xD: TG268

3-3.5xD: TG269

Modular type: TG272

5-6xD: TG270

Inch chamfering: TG273

8xD: TG271

BUY 6 drill heads

AND

GET 1 drill body

5xD, 6xD, and Inch Chamfering

FREE
of charge!

Drill heads (Grades: AH725, AH9130, KS15F):

DMP, DMC, DMF, DMH, DMN, DMM

Drill bodies:

TID-F (1.5xD, 3xD, 5xD, 8xD)

TID-R (2xD, 3.5xD, 6xD, 8xD)

TIDC (3xD, 5xD)

Modular drill bodies:

TID-M (2xD, 3xD)

TID-S (2xD)

TID-L-A-M

Inch chamfering:

TID-L-A

BUY 8 drill heads

AND

GET 1 drill body

up to 8xD

FREE
of charge!



DRILL HEADS LINEUP



DMP

Drill dia.:
ø0.236" - ø1.020"
(ø6 - ø25.9 mm)

General purpose drilling head ideal for various drilling applications



DMC

Drill dia.:
ø0.236" - ø1.020"
(ø6 - ø25.9 mm)

High-precision head with double margin and self-centering edge



DMF

Drill dia.:
ø0.236" - ø1.020"
(ø6 - ø25.9 mm)

180° flat edges for counterboring and flat bottoms



DMH

Drill dia.:
ø0.236" - ø1.020"
(ø6 - ø25.9 mm)

General purpose head with enhanced cutting edge



DMN

Drill dia.:
ø0.268" - ø0.768"
(ø6.8 - ø19.5 mm)

Drill head with sharp edges for non-ferrous materials



DMM

Drill dia.:
ø0.393" - ø0.783"
(ø10 - ø19.9 mm)

General purpose drilling head for stainless steel and superalloy materials

DRILL BODIES LINEUP

TIDC

Drill dia.:
ø0.295" - ø0.783"
(ø7.5 - ø19.9 mm)
3xD and 5xD



TID-F

Drill dia.:
ø0.236" - ø1.020"
(ø6 - ø25.9 mm)
1.5xD, 3xD, 5xD, 8xD



TID-R / TID-R-E

Drill dia.:
ø0.236" - ø0.783"
(ø6 - ø19.9 mm)
2xD, 3.5xD, 6xD, 8xD



TID-L-A

3/8" - 7/8" UNC/UNF Tap Sizes
Inch chamfer for tap sizes

MODULAR DRILL BODIES LINEUP

video



TID-M

Drill dia.:
ø0.236" - ø0.744"
(ø6 - ø18.9 mm)
2xD and 3xD

TungFlex connection

video



TID-S

Drill dia.:
ø0.256" - ø0.429"
(ø6.5 - ø10.9 mm)
2xD

TungMeister connection



TID-L-A-M

Drill dia.:
ø0.256" - ø0.665"
(ø6.5 - ø16.9 mm)
TungFlex connection
drilling+chamfering /
pre-thread drilling

TMV Chipbreaker Series

Valid from January 1st to June 30th, 2026

NTK

TURNING & MINIATURE

OUTSTANDING CHIPBREAKER FOR CONVENTIONAL AND VIBRATION MACHINING

Advanced chipbreaker design for reliable performance & longer tool life

BUY 30 inserts

AND

GET 10 corresponding inserts

FREE
of charge!

Promo Code: NW010

*Offer must be ordered through our Customer Service Team, not available on Webshop.

Inserts (Grades DM4, TM4, ST4 and NTK650):
DCGT, DCGT-WP, TNGG, CCGT, VCGT

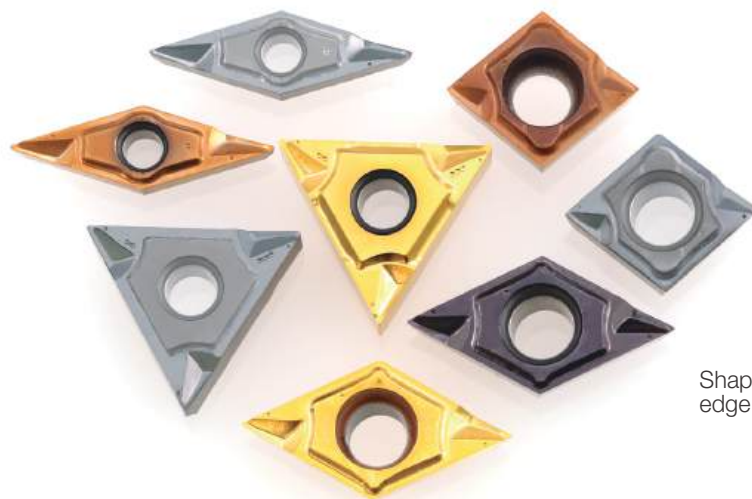

Controls chip flow reliably

Shape to prevent cutting edge damage from chipping

Rake face shape to withstand high cutting feeds

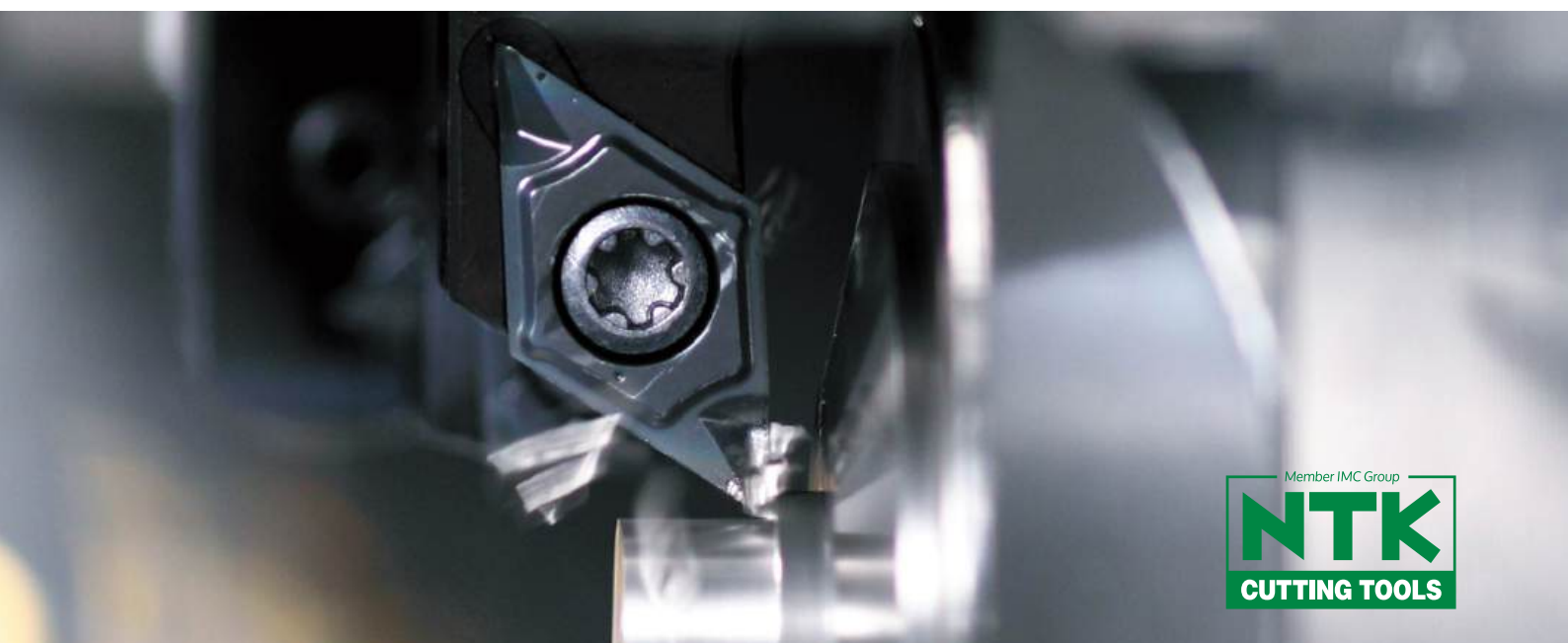
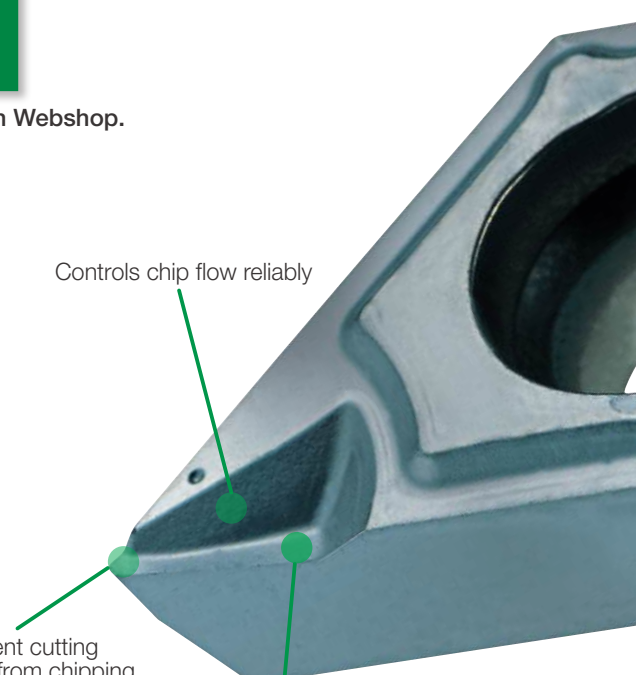

YL Chipbreaker Series

Valid from January 1st to June 30th, 2026

NTK

TURNING & MINIATURE

FIRST RECOMMENDATION FOR FRONT TURNING OPERATIONS

Combination of sharpness, toughness, and chip control to handle an extremely wide range of cutting conditions

BUY 30 inserts

AND

GET 10 corresponding inserts

FREE
of charge!

Promo Code: NW011

*Offer must be ordered through our Customer Service Team, not available on Webshop.

Inserts (Grades DM4, DT4, TM4, ST4, QM3 and NTK650):
DCGT, CCGT, VBG, VCGT



Member IMC Group
NTK
CUTTING TOOLS

N-SWISS JOINT

Valid from January 1st to June 30th, 2026

NTK

TURNING & MINIATURE

QUICK-CHANGE MODULAR-TYPE TOOL SERIES FOR AUTOMATIC LATHES

Multiple heads compatible with a single shank, covering a broad range of applications.

BUY 1 modular head
and **10** inserts

AND

GET 1 corresponding
shank

FREE
of charge!

Promo Code: NW012

Inserts (Grades NTK650, ST4, DM4, DT4, QM3, TM4, VM1, ZM3):

ISO inserts

Modular heads (QC10, QC12, QC16):

Front turning: SDJC, SCLC, PTXN, SVJC

Toolholders:

QC-1012-OH2

QC-1212-OH/OH2

QC-1216-OH/OH2

QC-1616-OH2

QC-06H-IN-OH2

QC-08F-IN-OH

QC-08X-IN-OH2

QC-10X-IN-OH2

BUY 1 modular head
and **10** inserts

AND

GET 1 corresponding
modular head at

50 %
*additional
discount!*

Promo Code: NW012



SCLC



SDJC



PTXN



SVJC

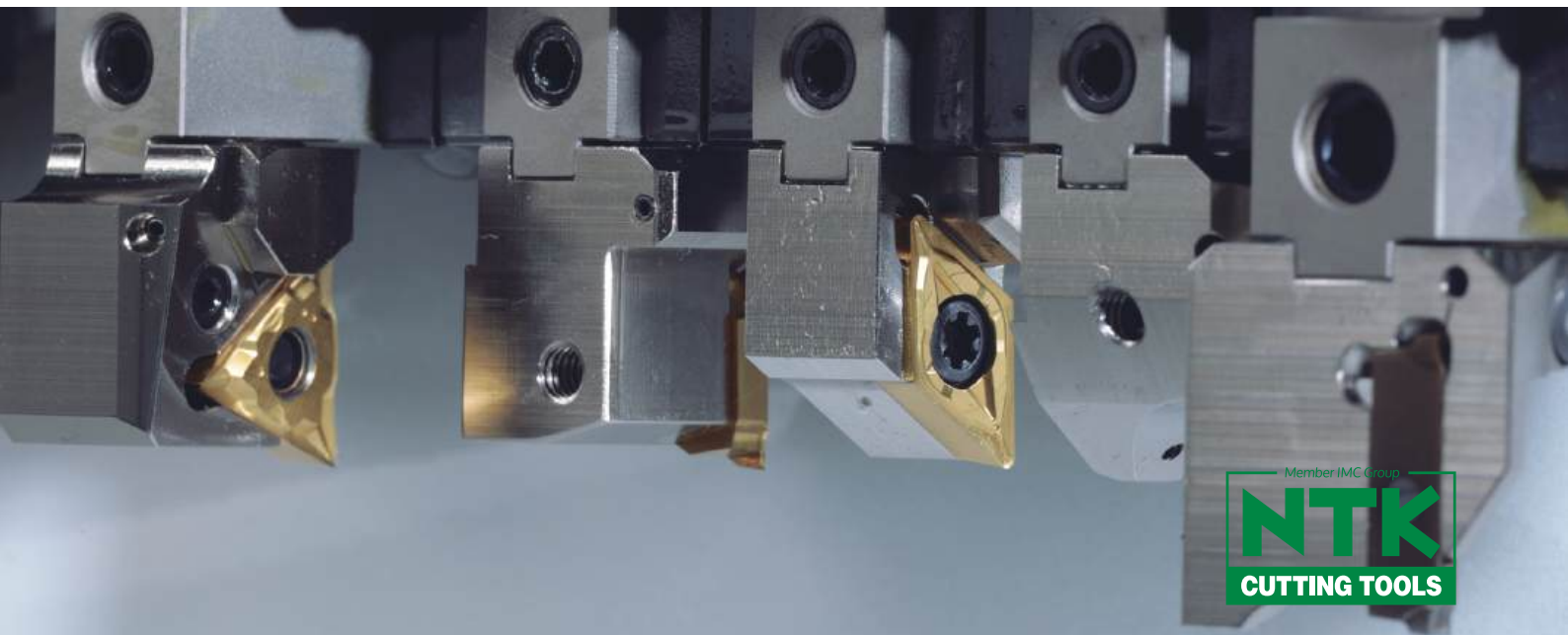

Member IMC Group
NTK
CUTTING TOOLS

DS-ACH Holder Series

Valid from January 1st to June 30th, 2026

NTK

TURNING & MINIATURE

DESIGNED TO EASILY ADJUST THE CUTTING EDGE HEIGHT IN MACHINES WITHOUT Y2 AXIS CAPABILITY

BUY 20 ISO inserts

AND

GET 1 corresponding toolholder at

50 % additional discount!

Promo Code: NW013

Inserts (Grades 650, ST4, DM4, DT4, QM3, TM4, VM1, ZM3):

ISO inserts

Toolholders:

DS-PTX-ACH-OH
DS-PTX-ACH
DS-SCL-ACH
DS-SDU-ACH-OH
DS-SDU-ACH
DS-SVVPN-ACH

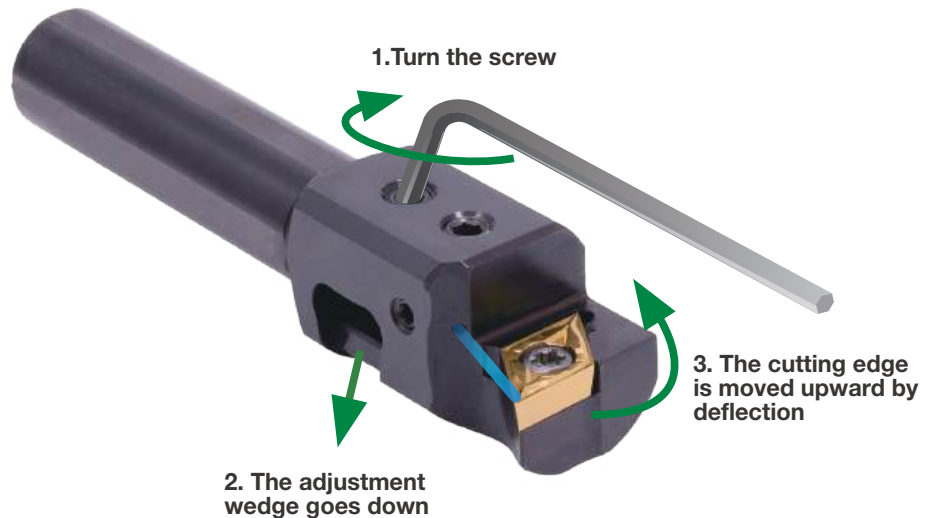

Range of centerline adjustment: 0" - 0.008"

Height adjustment of the cutting edge is done by turning a screw and bending the tip of the holder with a wedge mechanism. Patented holder design improves rigidity, compared to conventional holders, to eliminate vibration

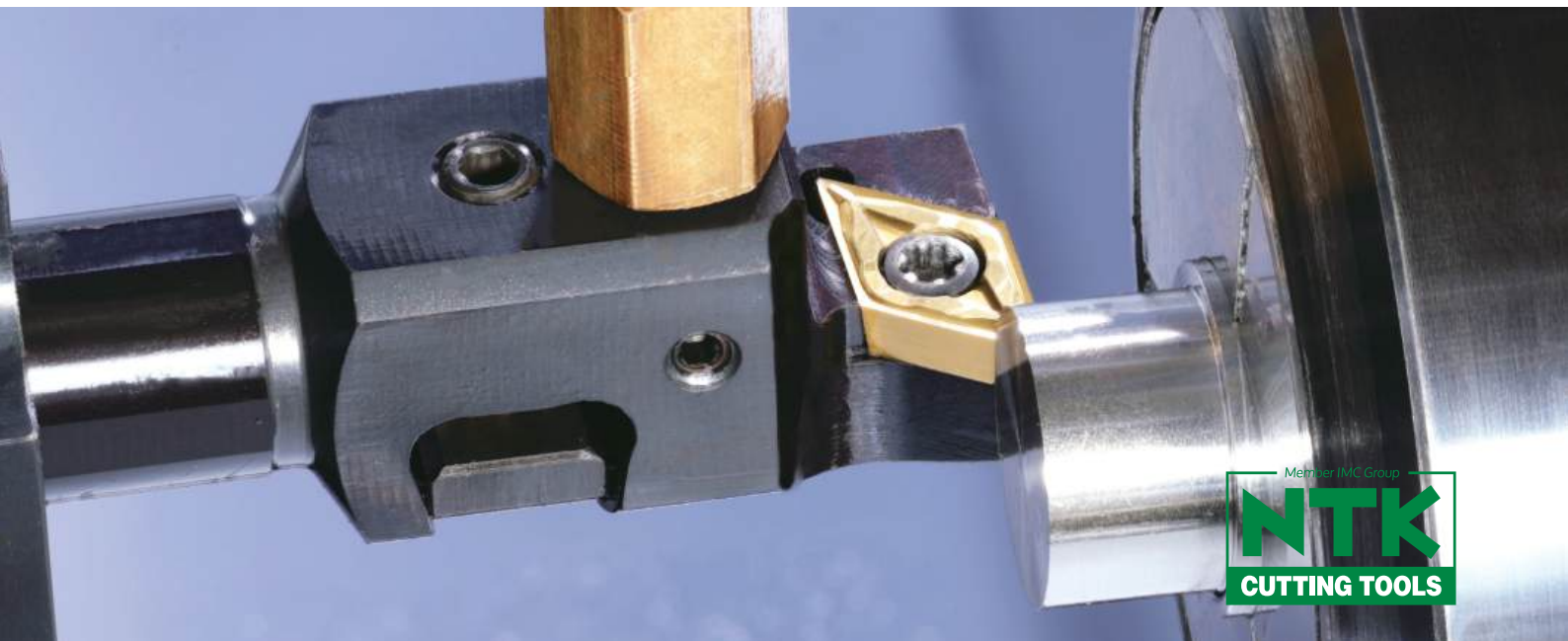

YOUR GATEWAY TO TUNGALOY & NTK SUCCESS REPORTS!

We invite you to visit the updated TSR platform and discover how Tungaloy and NTK's products have successfully met diverse challenges and delivered outstanding results. These reports can provide insights and inspiration for your own applications and projects, offering detailed solutions to succeed in various industrial fields.

Find applications that fit your current needs, elevate your productivity, and solve your production bottlenecks.

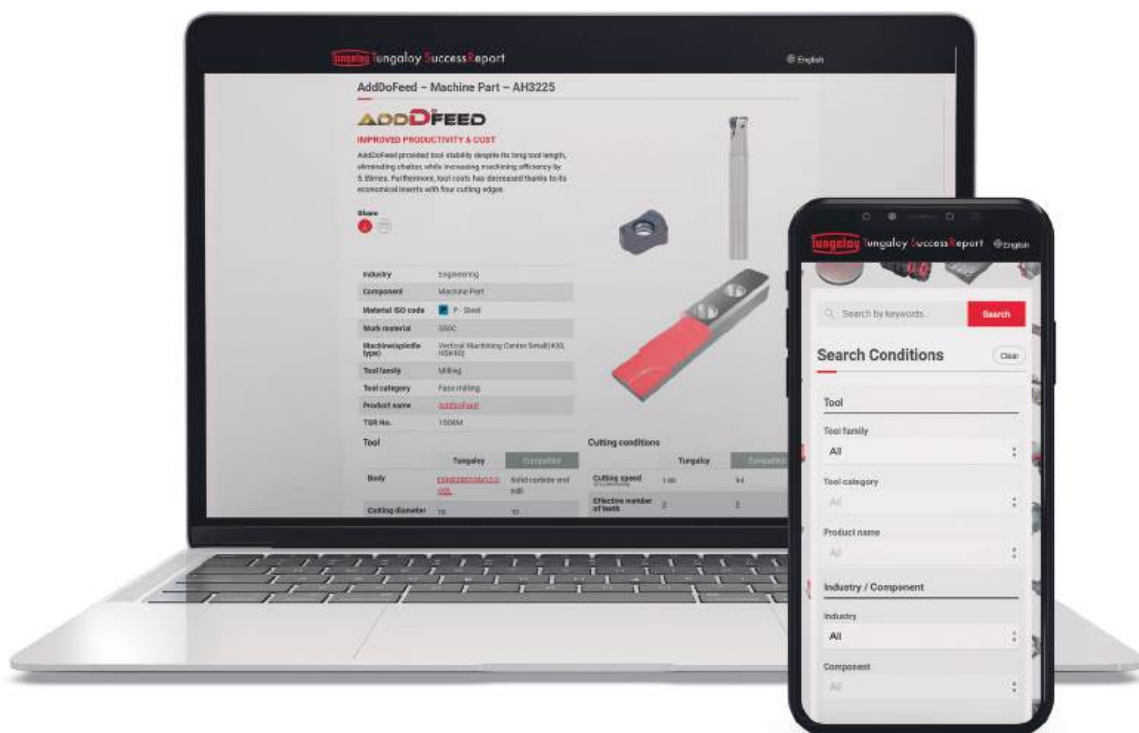

tsr.tungaloy.com

Tungaloy-NTK America Promotion Details:

- Valid January 1 - June 30, 2026
- Orders must be drop shipped to the end user
- Promo code must be included at time of order
- Prices valid in U.S. only
- No returns



Tungaloy-NTK America Inc.
3726 N Ventura Drive
Arlington Heights, IL 60004, U.S.A.
www.tungaloy.com/us

L e a d i n g i n I n n o v a t i o n

Distributed by:



AFC Tooling
AFCTooling.com



 FIND US ON THE CLOUD!
machiningcloud.com

Dec. 2025 (TA)